

**MITSUBISHI**

MITSUBISHI CARBIDE

**TOOL NEWS**

B054A

MSTAR END MILL SERIES

**MS2XL MS4LT**

**Product  
Expansion**

**364 SIZES**

**Newly developed long neck and taper  
end mills for rib processing.**

Wide variety of neck lengths and taper angles.



MSTAR End Mill Series

**MS2XL**

2 flute long neck end mill

**MS4LT**

4 flute taper necked end mill for rib processing

**364 SIZES**

Wide variety of neck lengths and taper angles.

**Newly developed long neck and taper end mills for rib processing.**

## ■ Features

- High performance and long tool life as a result of "MS Coating" which utilizes MIRACLE coating technology

**MS2XL**

2 flute long neck end mill

φ 0.2 – 6mm 119 size

- 2 flute long neck end mill with neck relief. Suitable for straight rib slotting, deep milling or milling near vertical wall.

**MS4LT**

4 flute for rib processing taper neck end mill

φ 0.2 – 3mm 245 size

- 4 flute taper end mill designed for deep rib slotting. Suitable for all types of taper rib slotting.

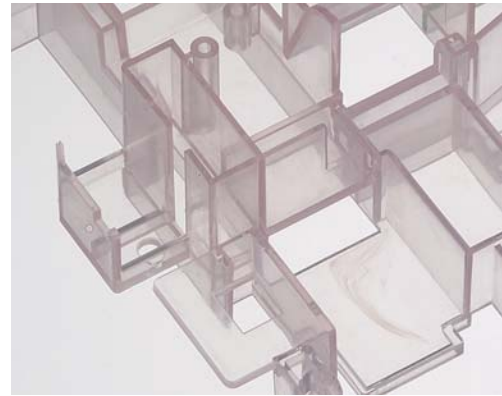
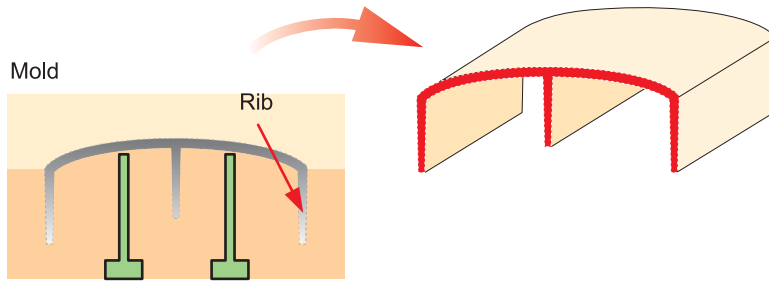

## Machining example

### Cutting Performance of MS2XL

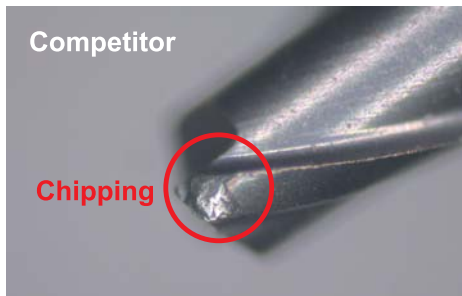
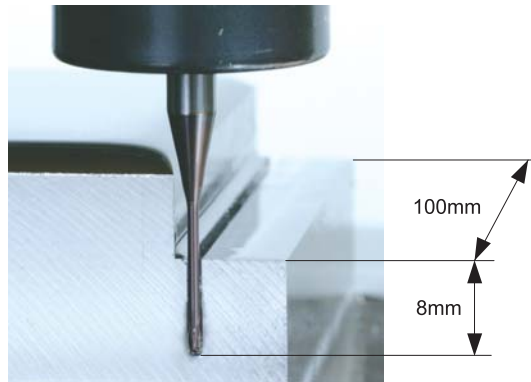
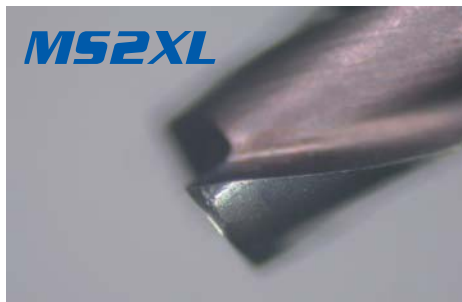

#### Cutting conditions

End mill	MS2XL $\phi 1 \times 12$
Work material	Tool Steel
Revolution	20,000 min <sup>-1</sup>
Feed rate	20 IPM (0.0004 IPT)
Depth of cut	0.02mm $\times$ 400 times (Slotting)
Cutting method	Oil

### Cutting Performance of MS4LT

#### [Results]

**Competitor's end mill** could not process even 1 piece as a result of fracturing. **MSTAR end mill "MS4LT"** processed 1 piece with minimal damage. In addition, **MS4LT** could process this work piece at **2,000mm/min feed rate**.

#### Cutting conditions

End mill	MS4LT $\phi 2 \times 1^\circ \times 25$
Work material	Tool Steel
Revolution	10,000 min <sup>-1</sup>
Feed rate	40 IPM (0.0004 IPT)
Depth of cut	Ad 0.03mm $\times$ Max. 830 times (Slant rib slot · Max. depth 25mm)
Cutting method	Water-soluble oil

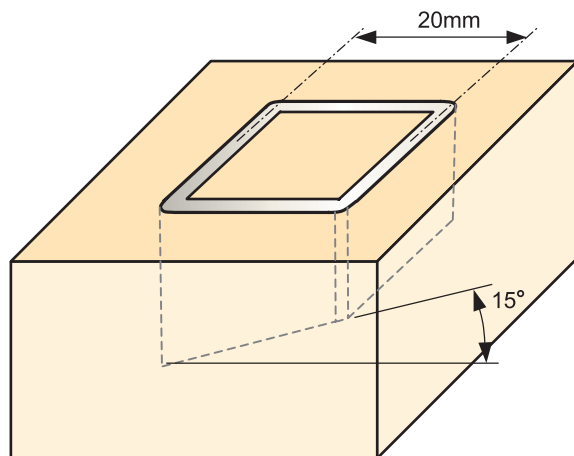

Slant & Blind Rib slot

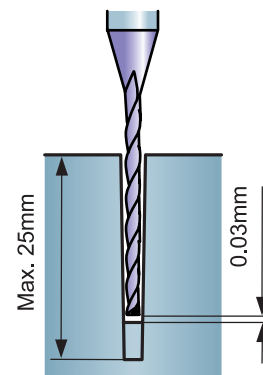

# MSTAR END MILLS

## MS2XL

2 flute long neck end mill



$D_1 < 0.5$  0 - -0.01  
 $0.5 \leq D_1$  0 - -0.02



$D_1 < 0.4$

$0.4 \leq D_1$

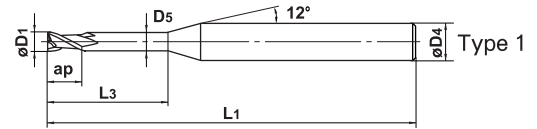

Type 1

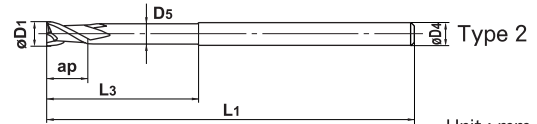

Type 2

Unit : mm

● 2 flute long neck end mill for general purpose

Order Number	Dia. D1	Length of Cut ap	Neck Length L3	Neck Dia. D5	Overall Length L1	Shank Dia. D4	No. of Flute N	Stock	Type
MS2XLD0020N005	0.2	0.3	0.5	0.18	45	4	2	★	1
MS2XLD0020N010	0.2	0.3	1	0.18	45	4	2	★	1
MS2XLD0020N015	0.2	0.3	1.5	0.18	45	4	2	★	1
MS2XLD0030N010	0.3	0.4	1	0.28	45	4	2	★	1
MS2XLD0030N020	0.3	0.4	2	0.28	45	4	2	★	1
MS2XLD0030N030	0.3	0.4	3	0.28	45	4	2	★	1
MS2XLD0030N060	0.3	0.4	6	0.28	45	4	2	★	1
MS2XLD0030N090	0.3	0.4	9	0.28	45	4	2	★	1
MS2XLD0040N020	0.4	0.6	2	0.37	45	4	2	★	1
MS2XLD0040N030	0.4	0.6	3	0.37	45	4	2	★	1
MS2XLD0040N040	0.4	0.6	4	0.37	45	4	2	★	1
MS2XLD0040N080	0.4	0.6	8	0.37	45	4	2	★	1
MS2XLD0040N120	0.4	0.6	12	0.37	45	4	2	★	1
MS2XLD0050N020	0.5	0.7	2	0.46	45	4	2	★	1
MS2XLD0050N040	0.5	0.7	4	0.46	45	4	2	●	1
MS2XLD0050N060	0.5	0.7	6	0.46	45	4	2	●	1
MS2XLD0050N080	0.5	0.7	8	0.46	50	4	2	●	1
MS2XLD0050N100	0.5	0.7	10	0.46	50	4	2	●	1
MS2XLD0050N150	0.5	0.7	15	0.46	50	4	2	●	1
MS2XLD0060N020	0.6	0.9	2	0.56	45	4	2	★	1
MS2XLD0060N040	0.6	0.9	4	0.56	45	4	2	★	1
MS2XLD0060N060	0.6	0.9	6	0.56	45	4	2	★	1
MS2XLD0060N080	0.6	0.9	8	0.56	50	4	2	★	1
MS2XLD0060N100	0.6	0.9	10	0.56	50	4	2	★	1
MS2XLD0060N120	0.6	0.9	12	0.56	50	4	2	★	1
MS2XLD0060N180	0.6	0.9	18	0.56	50	4	2	★	1
MS2XLD0070N020	0.7	1	2	0.66	45	4	2	★	1
MS2XLD0070N040	0.7	1	4	0.66	45	4	2	★	1
MS2XLD0070N060	0.7	1	6	0.66	45	4	2	★	1
MS2XLD0070N080	0.7	1	8	0.66	50	4	2	★	1
MS2XLD0070N100	0.7	1	10	0.66	50	4	2	★	1
MS2XLD0080N040	0.8	1.2	4	0.76	45	4	2	★	1
MS2XLD0080N060	0.8	1.2	6	0.76	45	4	2	★	1
MS2XLD0080N080	0.8	1.2	8	0.76	50	4	2	★	1
MS2XLD0080N100	0.8	1.2	10	0.76	50	4	2	★	1
MS2XLD0080N120	0.8	1.2	12	0.76	50	4	2	★	1
MS2XLD0080N160	0.8	1.2	16	0.76	50	4	2	★	1
MS2XLD0080N240	0.8	1.2	24	0.76	60	4	2	★	1

Order Number	Dia. D1	Length of Cut ap	Neck Length L3	Neck Dia. D5	Overall Length L1	Shank Dia. D4	No. of Flute N	Stock	Type
MS2XLD0090N060	0.9	1.4	6	0.86	45	4	2	★	1
MS2XLD0090N080	0.9	1.4	8	0.86	50	4	2	★	1
MS2XLD0090N100	0.9	1.4	10	0.86	50	4	2	★	1
MS2XLD0090N150	0.9	1.4	15	0.86	60	4	2	★	1
MS2XLD0100N040	1	1.5	4	0.95	50	4	2	●	1
MS2XLD0100N060	1	1.5	6	0.95	50	4	2	●	1
MS2XLD0100N080	1	1.5	8	0.95	50	4	2	●	1
MS2XLD0100N100	1	1.5	10	0.95	50	4	2	●	1
MS2XLD0100N120	1	1.5	12	0.95	50	4	2	●	1
MS2XLD0100N160	1	1.5	16	0.95	60	4	2	●	1
MS2XLD0100N200	1	1.5	20	0.95	60	4	2	●	1
MS2XLD0100N250	1	1.5	25	0.95	70	4	2	★	1
MS2XLD0100N300	1	1.5	30	0.95	70	4	2	★	1
MS2XLD0120N060	1.2	1.8	6	1.15	50	4	2	★	1
MS2XLD0120N080	1.2	1.8	8	1.15	50	4	2	★	1
MS2XLD0120N100	1.2	1.8	10	1.15	50	4	2	★	1
MS2XLD0120N120	1.2	1.8	12	1.15	50	4	2	★	1
MS2XLD0120N160	1.2	1.8	16	1.15	60	4	2	★	1
MS2XLD0120N200	1.2	1.8	20	1.15	60	4	2	★	1
MS2XLD0150N060	1.5	2.3	6	1.45	50	4	2	★	1
MS2XLD0150N080	1.5	2.3	8	1.45	50	4	2	★	1
MS2XLD0150N100	1.5	2.3	10	1.45	50	4	2	★	1
MS2XLD0150N120	1.5	2.3	12	1.45	50	4	2	★	1
MS2XLD0150N140	1.5	2.3	14	1.45	60	4	2	★	1
MS2XLD0150N160	1.5	2.3	16	1.45	60	4	2	★	1
MS2XLD0150N180	1.5	2.3	18	1.45	60	4	2	★	1
MS2XLD0150N200	1.5	2.3	20	1.45	60	4	2	★	1
MS2XLD0150N250	1.5	2.3	25	1.45	70	4	2	★	1
MS2XLD0150N300	1.5	2.3	30	1.45	70	4	2	★	1
MS2XLD0150N380	1.5	2.3	38	1.45	80	4	2	★	1
MS2XLD0150N450	1.5	2.3	45	1.45	80	4	2	★	1
MS2XLD0200N060	2	3	6	1.94	50	4	2	★	1
MS2XLD0200N080	2	3	8	1.94	50	4	2	★	1
MS2XLD0200N100	2	3	10	1.94	50	4	2	●	1
MS2XLD0200N120	2	3	12	1.94	50	4	2	★	1
MS2XLD0200N140	2	3	14	1.94	60	4	2	●	1
MS2XLD0200N160	2	3	16	1.94	60	4	2	●	1
MS2XLD0200N180	2	3	18	1.94	60	4	2	★	1
MS2XLD0200N200	2	3	20	1.94	60	4	2	●	1
MS2XLD0200N250	2	3	25	1.94	70	4	2	●	1
MS2XLD0200N300	2	3	30	1.94	70	4	2	●	1
MS2XLD0200N350	2	3	35	1.94	80	4	2	★	1
MS2XLD0200N400	2	3	40	1.94	90	4	2	★	1
MS2XLD0200N500	2	3	50	1.94	100	4	2	★	1
MS2XLD0200N600	2	3	60	1.94	110	4	2	★	1
MS2XLD0250N080	2.5	3.7	8	2.4	50	4	2	★	1
MS2XLD0250N120	2.5	3.7	12	2.4	50	4	2	●	1
MS2XLD0250N160	2.5	3.7	16	2.4	60	4	2	●	1

# MSTAR END MILLS

## MS2XL

2 flute long neck end mill



$D1 < 0.5$     0 - -0.01  
 $0.5 \leq D1$     0 - -0.02

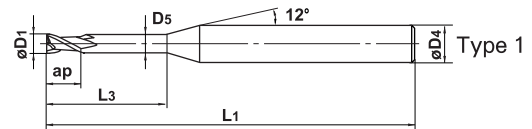

$D1 < 0.4$



$0.4 \leq D1$

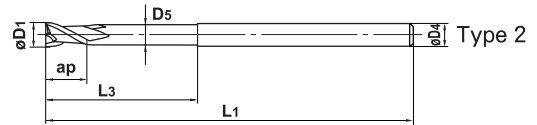

● 2 flute long neck end mill for general purpose

Unit : mm

Order Number	Dia. D1	Length of Cut ap	Neck Length L3	Neck Dia. D5	Overall Length L1	Shank Dia. D4	No. of Flute N	Stock	Type
MS2XLD0250N200	2.5	3.7	20	2.4	60	4	2	●	1
MS2XLD0250N250	2.5	3.7	25	2.4	70	4	2	●	1
MS2XLD0250N300	2.5	3.7	30	2.4	70	4	2	●	1
MS2XLD0250N400	2.5	3.7	40	2.4	90	4	2	★	1
MS2XLD0250N500	2.5	3.7	50	2.4	100	4	2	★	1
MS2XLD0300N080	3	4.5	8	2.85	50	6	2	★	1
MS2XLD0300N120	3	4.5	12	2.85	50	6	2	★	1
MS2XLD0300N160	3	4.5	16	2.85	60	6	2	●	1
MS2XLD0300N200	3	4.5	20	2.85	60	6	2	●	1
MS2XLD0300N250	3	4.5	25	2.85	70	6	2	●	1
MS2XLD0300N300	3	4.5	30	2.85	70	6	2	●	1
MS2XLD0300N400	3	4.5	40	2.85	90	6	2	●	1
MS2XLD0300N500	3	4.5	50	2.85	100	6	2	★	1
MS2XLD0400N120	4	6	12	3.8	50	6	2	★	1
MS2XLD0400N160	4	6	16	3.8	60	6	2	★	1
MS2XLD0400N200	4	6	20	3.8	60	6	2	★	1
MS2XLD0400N250	4	6	25	3.8	70	6	2	★	1
MS2XLD0400N300	4	6	30	3.8	70	6	2	★	1
MS2XLD0400N350	4	6	35	3.8	80	6	2	★	1
MS2XLD0400N400	4	6	40	3.8	90	6	2	★	1
MS2XLD0400N450	4	6	45	3.8	90	6	2	★	1
MS2XLD0400N500	4	6	50	3.8	100	6	2	★	1
MS2XLD0400N600	4	6	60	3.8	110	6	2	★	1
MS2XLD0500N160	5	7.5	16	4.8	60	6	2	●	1
MS2XLD0500N250	5	7.5	25	4.8	70	6	2	●	1
MS2XLD0500N350	5	7.5	35	4.8	80	6	2	●	1
MS2XLD0500N500	5	7.5	50	4.8	110	6	2	●	1
MS2XLD0500N600	5	7.5	60	4.8	120	6	2	★	1
MS2XLD0600N200	6	9	20	5.8	80	6	2	★	2
MS2XLD0600N300	6	9	30	5.8	90	6	2	★	2
MS2XLD0600N400	6	9	40	5.8	100	6	2	★	2
MS2XLD0600N500	6	9	50	5.8	110	6	2	★	2
MS2XLD0600N600	6	9	60	5.8	120	6	2	★	2

# MS4LT

4 flute taper neck end mill



$D_1 < 0.5$  0 - -0.02  
 $0.5 \leq D_1$  0 - -0.04



$\pm 5'$

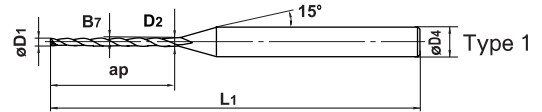

$D_1 < 3$



$3 \leq D_1$

● 4 flute taper neck end mill for rib processing

Unit : mm

Order Number	Small Mill Dia. D1	Taper Angle on Side B7	Large Mill Dia. D2	Length of Cut ap	Overall Length L1	Shank Dia. D4	No. of Flute N	Stock	Type
MS4LTD0020T0030L02	0.2	30'	0.23	2	40	3	4	★	1
MS4LTD0020T0100L02	0.2	1°	0.27	2	40	3	4	★	1
MS4LTD0020T0130L02	0.2	1° 30'	0.3	2	40	3	4	★	1
MS4LTD0020T0200L02	0.2	2°	0.34	2	40	3	4	★	1
MS4LTD0030T0030L03	0.3	30'	0.35	3	40	3	4	★	1
MS4LTD0030T0100L03	0.3	1°	0.4	3	40	3	4	★	1
MS4LTD0030T0130L03	0.3	1° 30'	0.46	3	40	3	4	★	1
MS4LTD0030T0200L03	0.3	2°	0.51	3	40	3	4	★	1
MS4LTD0040T0030L04	0.4	30'	0.47	4	40	3	4	★	1
MS4LTD0040T0100L04	0.4	1°	0.54	4	40	3	4	★	1
MS4LTD0040T0130L04	0.4	1° 30'	0.61	4	40	3	4	★	1
MS4LTD0040T0200L04	0.4	2°	0.68	4	40	3	4	★	1
MS4LTD0050T0030L04	0.5	30'	0.57	4	40	3	4	●	1
MS4LTD0050T0030L06	0.5	30'	0.6	6	40	3	4	●	1
MS4LTD0050T0100L04	0.5	1°	0.64	4	40	3	4	●	1
MS4LTD0050T0100L06	0.5	1°	0.71	6	40	3	4	●	1
MS4LTD0050T0130L04	0.5	1° 30'	0.71	4	40	3	4	●	1
MS4LTD0050T0130L06	0.5	1° 30'	0.81	6	40	3	4	●	1
MS4LTD0050T0200L04	0.5	2°	0.78	4	40	3	4	★	1
MS4LTD0050T0200L06	0.5	2°	0.92	6	40	3	4	★	1
MS4LTD0060T0030L04	0.6	30'	0.67	4	40	3	4	★	1
MS4LTD0060T0030L06	0.6	30'	0.7	6	40	3	4	★	1
MS4LTD0060T0100L04	0.6	1°	0.74	4	40	3	4	★	1
MS4LTD0060T0100L06	0.6	1°	0.81	6	40	3	4	★	1
MS4LTD0060T0130L04	0.6	1° 30'	0.81	4	40	3	4	★	1
MS4LTD0060T0130L06	0.6	1° 30'	0.91	6	40	3	4	★	1
MS4LTD0060T0200L04	0.6	2°	0.88	4	40	3	4	★	1
MS4LTD0060T0200L06	0.6	2°	1.02	6	40	3	4	★	1
MS4LTD0070T0030L06	0.7	30'	0.8	6	40	3	4	★	1
MS4LTD0070T0030L08	0.7	30'	0.84	8	45	3	4	★	1
MS4LTD0070T0100L06	0.7	1°	0.91	6	40	3	4	★	1
MS4LTD0070T0100L08	0.7	1°	0.98	8	45	3	4	★	1
MS4LTD0070T0130L06	0.7	1° 30'	1.01	6	40	3	4	★	1
MS4LTD0070T0130L08	0.7	1° 30'	1.12	8	45	3	4	★	1
MS4LTD0070T0200L06	0.7	2°	1.12	6	40	3	4	★	1
MS4LTD0070T0200L08	0.7	2°	1.26	8	45	3	4	★	1
MS4LTD0080T0015L04	0.8	15'	0.83	4	45	4	4	★	1
MS4LTD0080T0015L06	0.8	15'	0.85	6	45	4	4	★	1

● : Inventory maintained. ★ : Inventory maintained in Japan.

# MSTAR END MILLS

## MS4LT

4 flute taper neck end mill



$D_1 < 0.5$  0 - -0.02  
 $0.5 \leq D_1$  0 - -0.04



±5'

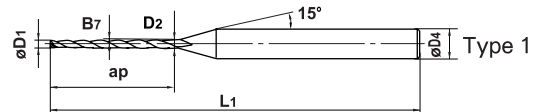

$D_1 < 3$



$3 \leq D_1$

● 4 flute taper neck end mill for rib processing

Unit : mm

Order Number	Small Mill Dia. D <sub>1</sub>	Taper Angle on Side B <sub>7</sub>	Large Mill Dia. D <sub>2</sub>	Length of Cut ap	Overall Length L <sub>1</sub>	Shank Dia. D <sub>4</sub>	No. of Flute N	Stock	Type
MS4LTD0080T0015L08	0.8	15'	0.87	8	45	4	4	★	1
MS4LTD0080T0015L10	0.8	15'	0.89	10	45	4	4	★	1
MS4LTD0080T0030L04	0.8	30'	0.87	4	45	4	4	★	1
MS4LTD0080T0030L06	0.8	30'	0.9	6	45	4	4	●	1
MS4LTD0080T0030L08	0.8	30'	0.94	8	45	4	4	●	1
MS4LTD0080T0030L10	0.8	30'	0.97	10	45	4	4	●	1
MS4LTD0080T0030L12	0.8	30'	1.01	12	50	4	4	●	1
MS4LTD0080T0100L04	0.8	1°	0.94	4	45	4	4	★	1
MS4LTD0080T0100L06	0.8	1°	1.01	6	45	4	4	●	1
MS4LTD0080T0100L08	0.8	1°	1.08	8	45	4	4	●	1
MS4LTD0080T0100L10	0.8	1°	1.15	10	45	4	4	●	1
MS4LTD0080T0100L12	0.8	1°	1.22	12	50	4	4	●	1
MS4LTD0080T0130L04	0.8	1° 30'	1.01	4	45	4	4	★	1
MS4LTD0080T0130L06	0.8	1° 30'	1.11	6	45	4	4	★	1
MS4LTD0080T0130L08	0.8	1° 30'	1.22	8	45	4	4	★	1
MS4LTD0080T0130L10	0.8	1° 30'	1.32	10	45	4	4	★	1
MS4LTD0080T0130L12	0.8	1° 30'	1.43	12	50	4	4	★	1
MS4LTD0080T0200L04	0.8	2°	1.08	4	45	4	4	★	1
MS4LTD0080T0200L06	0.8	2°	1.22	6	45	4	4	★	1
MS4LTD0080T0200L08	0.8	2°	1.36	8	45	4	4	★	1
MS4LTD0080T0200L10	0.8	2°	1.5	10	45	4	4	★	1
MS4LTD0080T0200L12	0.8	2°	1.64	12	50	4	4	★	1
MS4LTD0100T0015L06	1	15'	1.05	6	45	4	4	★	1
MS4LTD0100T0015L08	1	15'	1.07	8	45	4	4	★	1
MS4LTD0100T0015L10	1	15'	1.09	10	45	4	4	★	1
MS4LTD0100T0015L12	1	15'	1.1	12	50	4	4	★	1
MS4LTD0100T0030L06	1	30'	1.1	6	45	4	4	●	1
MS4LTD0100T0030L08	1	30'	1.14	8	45	4	4	●	1
MS4LTD0100T0030L10	1	30'	1.17	10	45	4	4	●	1
MS4LTD0100T0030L12	1	30'	1.21	12	50	4	4	●	1
MS4LTD0100T0100L06	1	1°	1.21	6	45	4	4	●	1
MS4LTD0100T0100L08	1	1°	1.28	8	45	4	4	●	1
MS4LTD0100T0100L10	1	1°	1.35	10	45	4	4	●	1
MS4LTD0100T0100L12	1	1°	1.42	12	50	4	4	●	1
MS4LTD0100T0100L16	1	1°	1.56	16	55	4	4	●	1
MS4LTD0100T0130L06	1	1° 30'	1.31	6	45	4	4	●	1
MS4LTD0100T0130L08	1	1° 30'	1.42	8	45	4	4	●	1
MS4LTD0100T0130L10	1	1° 30'	1.52	10	45	4	4	●	1

● : Inventory maintained. ★ : Inventory maintained in Japan.



Order Number	Small Mill Dia. D1	Taper Angle on Side B7	Large Mill Dia. D2	Length of Cut ap	Overall Length L1	Shank Dia. D4	No. of Flute N	Stock	Type
MS4LTD0100T0130L12	1	1° 30'	1.63	12	50	4	4	●	1
MS4LTD0100T0130L16	1	1° 30'	1.84	16	55	4	4	●	1
MS4LTD0100T0200L06	1	2°	1.42	6	45	4	4	★	1
MS4LTD0100T0200L08	1	2°	1.56	8	45	4	4	★	1
MS4LTD0100T0200L10	1	2°	1.7	10	45	4	4	★	1
MS4LTD0100T0200L12	1	2°	1.84	12	50	4	4	★	1
MS4LTD0100T0200L16	1	2°	2.12	16	55	4	4	★	1
MS4LTD0120T0015L06	1.2	15'	1.25	6	45	4	4	★	1
MS4LTD0120T0015L10	1.2	15'	1.29	10	45	4	4	★	1
MS4LTD0120T0015L12	1.2	15'	1.3	12	50	4	4	★	1
MS4LTD0120T0015L16	1.2	15'	1.34	16	55	4	4	★	1
MS4LTD0120T0030L06	1.2	30'	1.3	6	45	4	4	★	1
MS4LTD0120T0030L10	1.2	30'	1.37	10	45	4	4	★	1
MS4LTD0120T0030L12	1.2	30'	1.41	12	50	4	4	★	1
MS4LTD0120T0030L16	1.2	30'	1.48	16	55	4	4	★	1
MS4LTD0120T0100L06	1.2	1°	1.41	6	45	4	4	★	1
MS4LTD0120T0100L10	1.2	1°	1.55	10	45	4	4	★	1
MS4LTD0120T0100L12	1.2	1°	1.62	12	50	4	4	★	1
MS4LTD0120T0100L16	1.2	1°	1.76	16	55	4	4	★	1
MS4LTD0120T0100L20	1.2	1°	1.9	20	55	4	4	★	1
MS4LTD0120T0130L06	1.2	1° 30'	1.51	6	45	4	4	★	1
MS4LTD0120T0130L10	1.2	1° 30'	1.72	10	45	4	4	★	1
MS4LTD0120T0130L12	1.2	1° 30'	1.83	12	50	4	4	★	1
MS4LTD0120T0130L16	1.2	1° 30'	2.04	16	55	4	4	★	1
MS4LTD0120T0130L20	1.2	1° 30'	2.25	20	55	4	4	★	1
MS4LTD0120T0200L06	1.2	2°	1.62	6	45	4	4	★	1
MS4LTD0120T0200L10	1.2	2°	1.9	10	45	4	4	★	1
MS4LTD0120T0200L12	1.2	2°	2.04	12	50	4	4	★	1
MS4LTD0120T0200L16	1.2	2°	2.32	16	55	4	4	★	1
MS4LTD0120T0200L20	1.2	2°	2.6	20	55	4	4	★	1
MS4LTD0130T0030L12	1.3	30'	1.51	12	50	4	4	★	1
MS4LTD0130T0100L12	1.3	1°	1.72	12	50	4	4	★	1
MS4LTD0130T0130L12	1.3	1° 30'	1.93	12	50	4	4	★	1
MS4LTD0130T0200L12	1.3	2°	2.14	12	50	4	4	★	1
MS4LTD0140T0030L12	1.4	30'	1.61	12	50	4	4	★	1
MS4LTD0140T0100L12	1.4	1°	1.82	12	50	4	4	★	1
MS4LTD0140T0130L12	1.4	1° 30'	2.03	12	50	4	4	★	1
MS4LTD0140T0200L12	1.4	2°	2.24	12	50	4	4	★	1
MS4LTD0150T0015L06	1.5	15'	1.55	6	45	4	4	★	1
MS4LTD0150T0015L08	1.5	15'	1.57	8	45	4	4	★	1
MS4LTD0150T0015L10	1.5	15'	1.59	10	45	4	4	★	1
MS4LTD0150T0015L12	1.5	15'	1.6	12	50	4	4	★	1
MS4LTD0150T0015L16	1.5	15'	1.64	16	55	4	4	★	1
MS4LTD0150T0015L20	1.5	15'	1.67	20	55	4	4	★	1
MS4LTD0150T0030L06	1.5	30'	1.6	6	45	4	4	★	1
MS4LTD0150T0030L08	1.5	30'	1.64	8	45	4	4	★	1
MS4LTD0150T0030L10	1.5	30'	1.67	10	45	4	4	●	1
MS4LTD0150T0030L12	1.5	30'	1.71	12	50	4	4	★	1

# MSTAR END MILLS

## MS4LT

4 flute taper neck end mill



$D_1 < 0.5$  0 - -0.02  
 $0.5 \leq D_1$  0 - -0.04



±5'

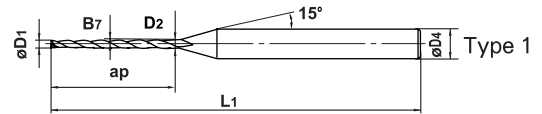

$D_1 < 3$



$3 \leq D_1$

● 4 flute taper neck end mill for rib processing

Unit : mm

Order Number	Small Mill Dia. $D_1$	Taper Angle on Side $B_7$	Large Mill Dia. $D_2$	Length of Cut $ap$	Overall Length $L_1$	Shank Dia. $D_4$	No. of Flute $N$	Stock	Type
MS4LTD0150T0030L16	1.5	30'	1.78	16	55	4	4	●	1
MS4LTD0150T0030L20	1.5	30'	1.85	20	55	4	4	★	1
MS4LTD0150T0100L06	1.5	1°	1.71	6	45	4	4	★	1
MS4LTD0150T0100L08	1.5	1°	1.78	8	45	4	4	★	1
MS4LTD0150T0100L10	1.5	1°	1.85	10	45	4	4	●	1
MS4LTD0150T0100L12	1.5	1°	1.92	12	50	4	4	★	1
MS4LTD0150T0100L16	1.5	1°	2.06	16	55	4	4	●	1
MS4LTD0150T0100L20	1.5	1°	2.2	20	55	4	4	★	1
MS4LTD0150T0100L25	1.5	1°	2.37	25	60	4	4	★	1
MS4LTD0150T0130L06	1.5	1° 30'	1.81	6	45	4	4	★	1
MS4LTD0150T0130L08	1.5	1° 30'	1.92	8	45	4	4	★	1
MS4LTD0150T0130L10	1.5	1° 30'	2.02	10	45	4	4	★	1
MS4LTD0150T0130L12	1.5	1° 30'	2.13	12	50	4	4	★	1
MS4LTD0150T0130L16	1.5	1° 30'	2.34	16	55	4	4	★	1
MS4LTD0150T0130L20	1.5	1° 30'	2.55	20	55	4	4	★	1
MS4LTD0150T0130L25	1.5	1° 30'	2.81	25	60	4	4	★	1
MS4LTD0150T0200L06	1.5	2°	1.92	6	45	4	4	★	1
MS4LTD0150T0200L08	1.5	2°	2.06	8	45	4	4	★	1
MS4LTD0150T0200L10	1.5	2°	2.2	10	45	4	4	★	1
MS4LTD0150T0200L12	1.5	2°	2.34	12	50	4	4	★	1
MS4LTD0150T0200L16	1.5	2°	2.62	16	55	4	4	★	1
MS4LTD0150T0200L20	1.5	2°	2.9	20	55	4	4	★	1
MS4LTD0150T0200L25	1.5	2°	3.25	25	60	4	4	★	1
MS4LTD0160T0030L08	1.6	30'	1.74	8	45	4	4	★	1
MS4LTD0160T0030L12	1.6	30'	1.81	12	50	4	4	★	1
MS4LTD0160T0030L16	1.6	30'	1.88	16	55	4	4	★	1
MS4LTD0160T0030L20	1.6	30'	1.95	20	55	4	4	★	1
MS4LTD0160T0100L08	1.6	1°	1.88	8	45	4	4	★	1
MS4LTD0160T0100L12	1.6	1°	2.02	12	50	4	4	★	1
MS4LTD0160T0100L16	1.6	1°	2.16	16	55	4	4	★	1
MS4LTD0160T0100L20	1.6	1°	2.3	20	55	4	4	★	1
MS4LTD0160T0130L08	1.6	1° 30'	2.02	8	45	4	4	★	1
MS4LTD0160T0130L12	1.6	1° 30'	2.23	12	50	4	4	★	1
MS4LTD0160T0130L16	1.6	1° 30'	2.44	16	55	4	4	★	1
MS4LTD0160T0130L20	1.6	1° 30'	2.65	20	55	4	4	★	1
MS4LTD0160T0200L08	1.6	2°	2.16	8	45	4	4	★	1
MS4LTD0160T0200L12	1.6	2°	2.44	12	50	4	4	★	1
MS4LTD0160T0200L16	1.6	2°	2.72	16	55	4	4	★	1

Order Number	Small Mill Dia. D <sub>1</sub>	Taper Angle on Side B <sub>7</sub>	Large Mill Dia. D <sub>2</sub>	Length of Cut ap	Overall Length L <sub>1</sub>	Shank Dia. D <sub>4</sub>	No. of Flute N	Stock	Type
MS4LTD0160T0200L20	1.6	2°	3	20	55	4	4	★	1
MS4LTD0180T0015L08	1.8	15'	1.87	8	45	4	4	★	1
MS4LTD0180T0015L16	1.8	15'	1.94	16	55	4	4	★	1
MS4LTD0180T0015L24	1.8	15'	2.01	24	60	4	4	★	1
MS4LTD0180T0030L08	1.8	30'	1.94	8	45	4	4	★	1
MS4LTD0180T0030L16	1.8	30'	2.08	16	55	4	4	★	1
MS4LTD0180T0030L24	1.8	30'	2.22	24	60	4	4	★	1
MS4LTD0180T0100L08	1.8	1°	2.08	8	45	4	4	★	1
MS4LTD0180T0100L16	1.8	1°	2.36	16	55	4	4	★	1
MS4LTD0180T0100L24	1.8	1°	2.64	24	60	4	4	★	1
MS4LTD0180T0130L08	1.8	1° 30'	2.22	8	45	4	4	★	1
MS4LTD0180T0130L16	1.8	1° 30'	2.64	16	55	4	4	★	1
MS4LTD0180T0130L24	1.8	1° 30'	3.06	24	60	4	4	★	1
MS4LTD0180T0200L08	1.8	2°	2.36	8	45	4	4	★	1
MS4LTD0180T0200L16	1.8	2°	2.92	16	55	4	4	★	1
MS4LTD0180T0200L24	1.8	2°	3.48	24	60	4	4	★	1
MS4LTD0200T0015L08	2	15'	2.07	8	45	4	4	★	1
MS4LTD0200T0015L10	2	15'	2.09	10	45	4	4	★	1
MS4LTD0200T0015L12	2	15'	2.1	12	50	4	4	★	1
MS4LTD0200T0015L16	2	15'	2.14	16	55	4	4	★	1
MS4LTD0200T0015L20	2	15'	2.17	20	55	4	4	★	1
MS4LTD0200T0015L25	2	15'	2.22	25	60	4	4	★	1
MS4LTD0200T0030L08	2	30'	2.14	8	45	4	4	★	1
MS4LTD0200T0030L10	2	30'	2.17	10	45	4	4	●	1
MS4LTD0200T0030L12	2	30'	2.21	12	50	4	4	★	1
MS4LTD0200T0030L16	2	30'	2.28	16	55	4	4	★	1
MS4LTD0200T0030L20	2	30'	2.35	20	55	4	4	●	1
MS4LTD0200T0030L25	2	30'	2.44	25	60	4	4	★	1
MS4LTD0200T0030L30	2	30'	2.52	30	65	4	4	★	1
MS4LTD0200T0100L08	2	1°	2.28	8	45	4	4	★	1
MS4LTD0200T0100L10	2	1°	2.35	10	45	4	4	●	1
MS4LTD0200T0100L12	2	1°	2.42	12	50	4	4	★	1
MS4LTD0200T0100L16	2	1°	2.56	16	55	4	4	●	1
MS4LTD0200T0100L20	2	1°	2.7	20	55	4	4	●	1
MS4LTD0200T0100L25	2	1°	2.87	25	60	4	4	★	1
MS4LTD0200T0100L30	2	1°	3.05	30	65	4	4	★	1
MS4LTD0200T0130L08	2	1° 30'	2.42	8	45	4	4	★	1
MS4LTD0200T0130L10	2	1° 30'	2.52	10	45	4	4	●	1
MS4LTD0200T0130L12	2	1° 30'	2.63	12	50	4	4	★	1
MS4LTD0200T0130L16	2	1° 30'	2.84	16	55	4	4	●	1
MS4LTD0200T0130L20	2	1° 30'	3.05	20	55	4	4	●	1
MS4LTD0200T0130L25	2	1° 30'	3.31	25	60	4	4	★	1
MS4LTD0200T0130L30	2	1° 30'	3.57	30	65	4	4	★	1
MS4LTD0200T0200L08	2	2°	2.56	8	45	4	4	★	1
MS4LTD0200T0200L10	2	2°	2.7	10	45	4	4	★	1
MS4LTD0200T0200L12	2	2°	2.84	12	50	4	4	★	1
MS4LTD0200T0200L16	2	2°	3.12	16	55	4	4	★	1
MS4LTD0200T0200L20	2	2°	3.4	20	55	4	4	★	1

# MSTAR END MILLS

## MS4LT

4 flute taper neck end mill



$D_1 < 0.5$  0 - -0.02  
 $0.5 \leq D_1$  0 - -0.04



$\pm 5'$

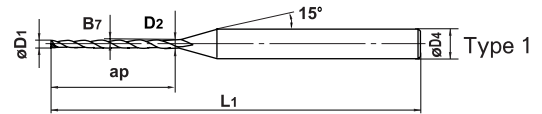

● 4 flute taper neck end mill for rib processing

Unit : mm

Order Number	Small Mill Dia. D1	Taper Angle on Side B7	Large Mill Dia. D2	Length of Cut ap	Overall Length L1	Shank Dia. D4	No. of Flute N	Stock	Type
MS4LTD0200T0200L25	2	2°	3.75	25	60	4	4	★	1
MS4LTD0200T0200L30	2	2°	4.1	30	65	6	4	★	1
MS4LTD0200T0300L12	2	3°	3.26	12	50	4	4	★	1
MS4LTD0200T0300L16	2	3°	3.68	16	55	4	4	★	1
MS4LTD0200T0300L20	2	3°	4.1	20	55	6	4	★	1
MS4LTD0200T0300L25	2	3°	4.62	25	60	6	4	★	1
MS4LTD0200T0300L30	2	3°	5.14	30	65	6	4	★	1
MS4LTD0250T0030L10	2.5	30'	2.67	10	45	4	4	★	1
MS4LTD0250T0030L16	2.5	30'	2.78	16	50	4	4	★	1
MS4LTD0250T0030L20	2.5	30'	2.85	20	55	4	4	★	1
MS4LTD0250T0030L25	2.5	30'	2.94	25	60	4	4	★	1
MS4LTD0250T0030L30	2.5	30'	3.02	30	65	4	4	★	1
MS4LTD0250T0100L10	2.5	1°	2.85	10	45	4	4	★	1
MS4LTD0250T0100L16	2.5	1°	3.06	16	50	4	4	★	1
MS4LTD0250T0100L20	2.5	1°	3.2	20	55	4	4	★	1
MS4LTD0250T0100L25	2.5	1°	3.37	25	60	4	4	★	1
MS4LTD0250T0100L30	2.5	1°	3.55	30	65	4	4	★	1
MS4LTD0250T0130L10	2.5	1° 30'	3.02	10	45	4	4	★	1
MS4LTD0250T0130L16	2.5	1° 30'	3.34	16	50	4	4	★	1
MS4LTD0250T0130L20	2.5	1° 30'	3.55	20	55	4	4	★	1
MS4LTD0250T0130L25	2.5	1° 30'	3.81	25	60	4	4	★	1
MS4LTD0250T0130L30	2.5	1° 30'	4.07	30	65	6	4	★	1
MS4LTD0250T0200L10	2.5	2°	3.2	10	45	4	4	★	1
MS4LTD0250T0200L16	2.5	2°	3.62	16	50	4	4	★	1
MS4LTD0250T0200L20	2.5	2°	3.9	20	55	4	4	★	1
MS4LTD0250T0200L25	2.5	2°	4.25	25	60	6	4	★	1
MS4LTD0250T0200L30	2.5	2°	4.6	30	65	6	4	★	1
MS4LTD0300T0030L25	3	30'	3.44	25	65	6	4	★	1
MS4LTD0300T0030L40	3	30'	3.7	40	80	6	4	★	1
MS4LTD0300T0100L25	3	1°	3.87	25	65	6	4	★	1
MS4LTD0300T0100L40	3	1°	4.4	40	80	6	4	★	1
MS4LTD0300T0130L25	3	1° 30'	4.31	25	65	6	4	★	1
MS4LTD0300T0130L40	3	1° 30'	5.09	40	80	6	4	★	1
MS4LTD0300T0200L25	3	2°	4.75	25	65	6	4	★	1
MS4LTD0300T0200L40	3	2°	5.79	40	80	6	4	★	1

# MS2XL

## 2 flute long neck end mill

Work material		Structural steel, Carbon steel, AISI 1049, AISI 1055 Alloy steel, Tool steel, Pre-hardened steel				Pre-hardened steel AISI H13, Stainless Steel (40-45HRC)			
Dia. (mm)	Neck length (mm)	Revolution (min <sup>-1</sup> )	Feed rate (mm/min)	Table Feed (IPM)	Cutting depth a time (ap=mm)	Revolution (min <sup>-1</sup> )	Feed rate (mm/min)	Table Feed (IPM)	Cutting depth a time (ap=mm)
0.2	0.5	40,000	200-400	7.9-15.8	0.01	30,000	150-400	5.9-15.8	0.01
	0.002				0.002				
0.3	1	32,000-40,000	200-600	7.9-23.6	0.01	22,000-30,000	150-500	5.9-19.7	0.01
	3				0.002				0.002
	9				0.001				0.001
0.4	2	25,000-40,000	200-800	7.9-31.5	0.01	17,000-30,000	150-600	5.9-23.6	0.01
	4				0.003				0.003
	12				0.001				0.001
0.5	2	20,000-40,000	250-1,000	9.8-39.4	0.015	14,000-30,000	150-800	5.9-31.5	0.015
	6				0.005				0.005
	10				0.002				0.002
	15				0.001				0.001
0.6	2	17,000-33,000	250-1,000	9.8-39.4	0.02	12,000-25,000	150-800	5.9-31.5	0.02
	6				0.01				0.01
	10				0.003				0.003
	18				0.001				0.001
0.7	2	15,000-29,000	250-1,000	9.8-39.4	0.02	11,000-22,000	150-800	5.9-31.5	0.02
	6				0.01				0.01
	10				0.005				0.005
0.8	4	13,000-25,000	250-1,000	9.8-39.4	0.03	10,000-20,000	150-800	5.9-31.5	0.03
	8				0.02				0.02
	12				0.003				0.003
	24				0.001				0.001
0.9	6	11,000-22,000	250-1,000	9.8-39.4	0.04	9,000-18,000	150-800	5.9-31.5	0.04
	10				0.03				0.03
	15				0.003				0.003
1	4	10,000-20,000	250-1,000	9.8-39.4	0.06	8,000-16,000	150-800	5.9-31.5	0.06
	8				0.04				0.04
	12				0.02				0.02
	20				0.003				0.003
1.2	30	8,000-16,000	250-1,000	9.8-39.4	0.001	6,500-13,000	150-800	5.9-31.5	0.001
	6				0.08				0.08
	12				0.03				0.03
1.5	20	6,500-13,000	250-1,000	9.8-39.4	0.005	5,000-10,000	150-800	5.9-31.5	0.005
	6				0.12				0.12
	12				0.07				0.07
	30				0.01				0.01
2	45	5,000-10,000	250-1,000	9.8-39.4	0.002	4,200-8,500	150-800	5.9-31.5	0.002
	6				0.18				0.18
	12				0.12				0.12
	20				0.05				0.05
	30				0.01				0.01
	40				0.003				0.003
2.5	60	4,500-9,000	250-1,000	9.8-39.4	0.001	4,000-8,000	150-800	5.9-31.5	0.001
	8				0.25				0.25
	16				0.15				0.15
	25				0.04				0.04
	40				0.01				0.01
3	50	4,300-8,500	250-1,000	9.8-39.4	0.005	3,700-7,500	150-800	5.9-31.5	0.005
	8				0.3				0.3
	16				0.2				0.2
	25				0.1				0.1
	40				0.02				0.02
4	50	3,200-6,400	200-750	7.9-29.6	0.012	2,800-5,600	150-600	5.9-23.6	0.012
	8				0.8				0.8
	12				0.25				0.25
	20				0.15				0.15
	30				0.05				0.05
5	45	2,600-5,100	200-600	7.9-23.6	0.018	2,200-4,500	150-500	5.9-19.7	0.018
	60				1				1
	16				0.2				0.2
	35				0.05				0.05
6	20	2,100-4,200	200-500	7.9-19.7	1.2	1,900-3,700	150-400	5.9-15.8	1.2
	40				0.25				0.25
	60				0.1				0.1

- 1) The above table shows the revolution and feed rate for each neck length. Please reduce the revolution and feed rate when using end mills with longer neck length.
- 2) If the rigidity of the machine or the work material installation is very low, or chattering is generated, please reduce the revolution and the feed rate proportionately. Please reduce the feed rate when precision surface is important.

Work material		Carbon steel, Alloy steel, Tool steel, Pre-hardened steel AISI 1049, AISI H13, Stainless Steel (-45HRC)				Hardened steel AISI H13 (45-52HRC)			
Small mill dia. (mm)	Length of cut (mm)	Revolution (min <sup>-1</sup> )	Feed rate (mm/min)	Table Feed (IPM)	Cutting depth a time (ap=mm)	Revolution (min <sup>-1</sup> )	Feed rate (mm/min)	Table Feed (IPM)	Cutting depth a time (ap=mm)
0.2	2	20,000-40,000	200-500	7.9-19.7	0.001	20,000-40,000	150-300	5.9-11.8	0.001
0.3	3	20,000-40,000	200-500	7.9-19.7	0.002	20,000-40,000	150-300	5.9-11.8	0.001
0.4	4	20,000-40,000	200-500	7.9-19.7	0.003	20,000-36,000	150-300	5.9-11.8	0.002
0.5	4	20,000-38,000	200-500	7.9-19.7	0.01	16,000-29,000	200-400	7.9-15.8	0.005
	6				0.005				
0.6	4	18,000-32,000	250-600	9.8-23.6	0.01	13,000-24,000	200-400	7.9-15.8	0.005
	6				0.007				0.004
0.7	6	16,000-27,000	250-600	9.8-23.6	0.015	11,000-20,000	200-400	7.9-15.8	0.008
	8				0.01				0.005
0.8	4	14,000-24,000	250-600	9.8-23.6	0.03	10,000-18,000	200-400	7.9-15.8	0.015
	8				0.02				0.01
	12				0.013				0.007
1.0	6	11,000-19,000	300-800	11.8-31.5	0.03	8,000-14,000	200-500	7.9-19.7	0.015
	10				0.02				0.01
	16				0.015				0.008
1.2	6	9,200-16,000	300-800	11.8-31.5	0.04	6,600-12,000	200-500	7.9-19.7	0.02
	10				0.03				0.015
	16				0.02				0.01
1.3	12	8,500-15,000	300-800	11.8-31.5	0.03	6,100-11,000	200-500	7.9-19.7	0.015
1.4	12	8,000-14,000	300-800	11.8-31.5	0.035	5,700-10,000	200-500	7.9-19.7	0.018
1.5	6	7,500-13,000	300-800	11.8-31.5	0.06	5,300-9,500	200-500	7.9-19.7	0.03
	10				0.04				0.02
	16				0.03				0.015
	25				0.015				0.008
1.6	8	7,000-12,000	300-800	11.8-31.5	0.06	5,000-9,000	200-500	7.9-19.7	0.03
	12				0.045				0.025
	16				0.035				0.02
	20				0.025				0.015
1.8	8	6,200-11,000	300-800	11.8-31.5	0.08	4,400-8,000	200-500	7.9-19.7	0.04
	16				0.05				0.03
	24				0.03				0.015
2.0	8	5,500-9,500	300-800	11.8-31.5	0.1	4,000-7,200	200-500	7.9-19.7	0.05
	12				0.07				0.04
	20				0.04				0.02
	30				0.02				0.01
2.5	10	4,400-7,600	300-800	11.8-31.5	0.1	3,200-5,700	200-500	7.9-19.7	0.05
	20				0.06				0.03
	30				0.03				0.015
3.0	25	3,700-6,400	300-800	11.8-31.5	0.08	2,700-4,800	200-500	7.9-19.7	0.04
	40				0.04				0.02

- 1) The above table shows the revolution and feed rate for each neck length. Please reduce the feed rate when using end mills with longer neck length.
- 2) If the rigidity of the machine or the work material installation is very low, or chattering is generated, please reduce the revolution and the feed rate proportionately. Please reduce the feed rate when precision surface is important.

# SUGGESTIONS ON HOW TO USE CUTTING TOOLS

Products	Hazard	Countermeasure
All Cutting Tools	⊙Cutting tools have sharp cutting edges. Handling them with bare hands may cause injuries.	* Take precautions such as wearing gloves especially when handling tools during installation.
	⊙Improper use of tools and application of inappropriate cutting conditions may cause the tool to break and be expelled from the machine providing risk of injury.	* Ensure safety guards and goggles are used. Refer to handling explanatory notes and catalogs. Use tools under recommended cutting conditions.
	⊙Impact load and rapid increase of cutting resistance due to excessive wear may cause the tool to break and be expelled from the machine providing risk of injury.	* Ensure safety guards and goggles are used. Exchange tools before excessive wear occurs.
	⊙Cutting tools and workpieces become extremely hot during cutting. Touching them with bare hands may cause burns.	* Take precautions such as wearing gloves.
	⊙Expelled hot chips from cutting produces risk of injury and burns.	* Ensure safety guards and goggles are used. * During chip removal and machine cleaning ensure the machine is stopped and wear gloves. Use tools, such as cutting nippers and cutting clippers.
	⊙In cutting, sparks, hot chips and heat generation caused by tool breakage provides a risk of igniting a fire.	* Avoid using cutting tools in places where there is a possibility of igniting a fire. In case of using non-water soluble oil, make sure to have a fire prevention countermeasure.
	⊙Using machines, chucks, and tools with poor balance at high revolutions may cause tools to break providing risk of injuries.	* Ensure safety guards and goggles are used. Check the machine for vibration, chattering, and abnormal noise.
	⊙Handling machined parts with burrs using bare hands may cause injuries.	* Wear gloves.
Indexable Inserts	⊙If inserts and spare parts are not held securely, they may become loose and be expelled producing risk of injuries.	* Clean insert locating seat and spare parts before setting inserts. * Use the tool provided for setting inserts, and ensure the inserts and spare parts are clamped securely. Do not use the tool provided for things other than prescribed inserts and spare parts.
	⊙Clamping inserts and spare parts too tightly by using tools such as extension pipes may cause them to break and be expelled.	* Do not use extra tools for more leverage. Only use the tool provided.
	⊙When applying high cutting speed, spare parts and inserts may be expelled due to centrifugal force. Pay special attention on each safety guideline.	* Refer to the handling explanatory notes and catalogs. Use tools under recommended cutting conditions.
Cutters and Other Rotating Tools	⊙Milling cutters have sharp edges. Handling them with bare hands may cause injuries.	* Take precautions such as wearing gloves.
	⊙Poor balance or off center revolving tools may cause vibration and chattering which could cause the tool to break and be expelled.	* Apply cutting speed within the range of recommended cutting conditions. * Adjust accuracy and balance of spindles and bearings periodically to prevent off center revolving and chattering caused by wear on these parts.
Drills	⊙Through cutting in cases when the workpiece revolves may produce a disk shaped peice with sharp edges when the cutting tool breaks through.	* Ensure safety guards and goggles are used. Also install a cover on the chuck.
	⊙Drills with an extremely small diameter have a very sharp point which may puncture the skin if not handled carefully. If the drill breaks during cutting, the broken pieces may be expelled.	* Handle with care. Take precautions such as wearing gloves and goggles.
Brazed Tools	⊙When brazing is carried out time and again, the strength of carbide tip deteriorates and is easily broken during operation.	* Before using tools, ensure they are brazed securely. * Do not use them under conditions which produce very high temperature.
Others	⊙Machine and tools may be damaged if they are used for purposes other than the prescribed application.	* Use them strictly for the prescribed application.

## INFORMATION

This catalog completes the basic precautions for safety use of our company's products. For further information, please refer to the guideline, catalogs or contact us. We are not responsible for any accidents causing by modifying tools without our permission.



JQA-2522  
JQA-EM0941

**MITSUBISHI MATERIALS U.S.A. CORPORATION**

17401 Eastman Street, Irvine, California 92614, U.S.A.

TEL. 949-862-5100 FAX. 949-862-5180

Customer Service: (800) 523-0800 Technical Support: (800) 486-2341

Chicago Branch Office: 2401 Hassell Road, Northwest Tech Centre, Suite 1540, Hoffman Estates, Illinois 60195, U.S.A.

TEL. 847-285-6900 FAX. 847-285-3405

Detroit Branch Office: 39303 Country Club Drive, Suite A-1, Farmington Hills, Michigan 48331, U.S.A.

TEL. 248-489-1000 FAX. 248-489-3008

Toronto Branch Office: 6535 Millcreek Drive, Unit 63 & 64, Mississauga, Ontario, Canada L5N 2M2

TEL. 905-814-0240 FAX. 905-814-0245

**MMC METAL DE MEXICO S.A. DE C.V.**

Av. La Cañada No. 16, Parque Industrial Bernardo Quintana, El Marques, Queretaro, CP 76246 Mexico

TEL. 011-52-442-221-6136

FAX. 011-52-442-221-6134

011-52-442-221-6137

011-52-442-221-6150